

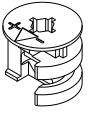









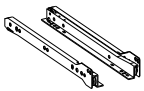

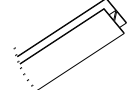
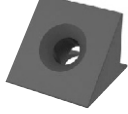



Minifix Çekirme	Minifix Mili	Plastik Kavela	Çekmece Rayı (45 cm.)	Alyan Başlı Vida	3,5 x 18 Vida	H Arkalık Çıtası	Arkalık Sabitleyici	Alyan Anahtar	Raf Pimi
 A01 40 Ad.	 A02 40 Ad.	 A03 36 Ad.	 A04 2 Takım	 A05 6 Ad.	 A06 80 Ad.	 A07 2 Ad.	 A08 18 Ad.	 A09 1 Ad.	 A10 24 Ad.
 A11 10 Ad.	 A12 10 Ad.	 A13 1 Ad.	 A14 1 Ad.	 A15 8 Ad.	 A16 15 Ad.	 A17 40 Ad.	 A18 2 Ad.	 A19 2 Ad.	 A20 2 Ad.

Sayın Müşterimiz,

Satın almış olduğunuz bu ürün sizlere ulaşmadan önce tarafımızdan tüm testlere ve kontrollere tabii tutulmuştur.

Bu durumda bile taşıma sırasında bazı parçaların zarar görmesi mümkündür. Böyle bir durum ile karşılaşırsanız ürünün tamamını geri göndermeyiniz. Sadece zarar gören parçayı isteyiniz. Gerekli parçayı isterken ise servis kartına bakarak tam olarak parçayı tanımlayınız.

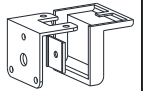
Eksik olan parça en hızlı şekilde tarafınıza gönderilecektir.

Montaja başlamadan önce kutulardan çıkan tüm parça ve aksesuarları listelere göre kontrol ediniz.

Parça ve aksesuarların tam ve sağlam olduğunu tespit ettikten sonra montaja başlayınız.

Montaja başlamadan önce her parçayı nemli bir bez ile temizleyiniz.

Eğer birden fazla ürün aldıysanız herhangi bir karışıklığa sebep vermemek için tek bir ürün montajını yaptıktan sonra diğer ürüne geçin.

Ürünleri hiç bir zaman sürterek taşımayınız. Ürünü kaldırarak ve sökerek en az iki kişi ile taşıyınız.

Uzun mesafeli taşımalarda ürünü mutlaka paket ile taşıyınız.

Almış olduğunuz mobilyalarının yüzeylerinin temizlenmesi çok kolaydır. Nemli ve sabunlu bir bez ile veya diğer ev temizleyicileriyle silmek yeterlidir.

Mobilyalar aşırı sıcak, soğuk ve nemden etkilendiklerinden, mobilyanızı bu faktörlere direkt olarak temas ettirmeyiniz.

Mobilyanızı amacı dışında kullanmayınız.

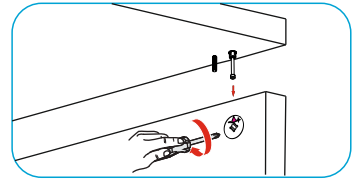
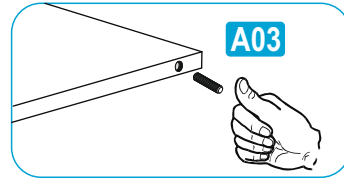
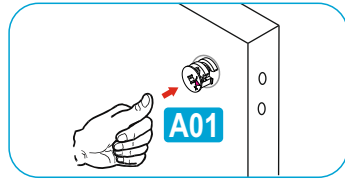
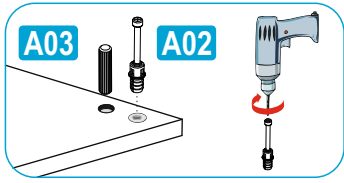

BU MODÜLÜN
KURULUMU İÇİN
GEREKLİ ARAÇLAR.

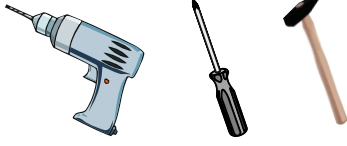

LÜTFEN !!!
BU ÜRÜNÜ YATIK HALDE VE EN AZ
2 KİŞİ TARAFINDAN KURUNUZ.



1. İşlem



5 numaraya takılacak
rayın görünüşü.

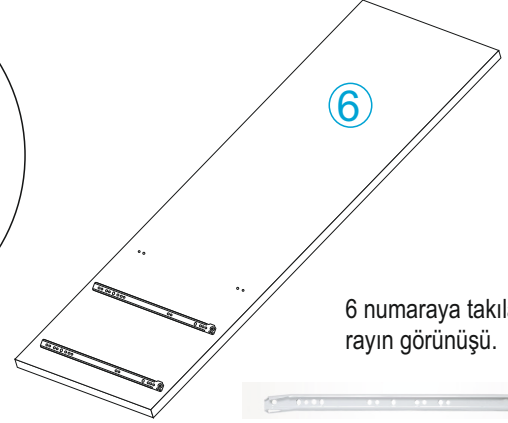
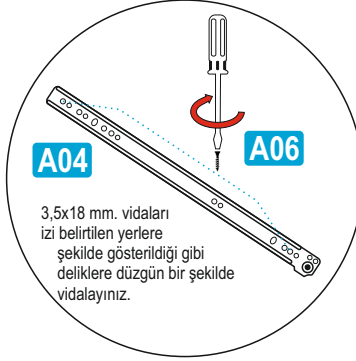

6 numaraya takılacak
rayın görünüşü.

2. İşlem

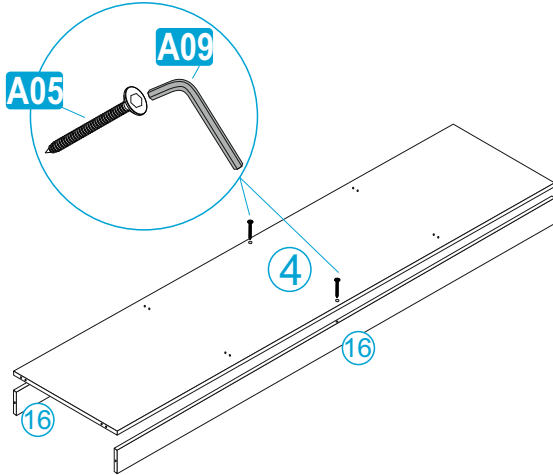

3. İşlem

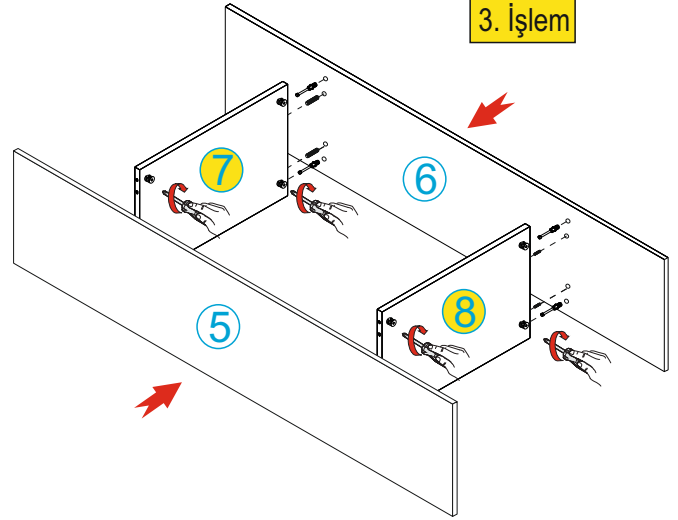

4. İşlem

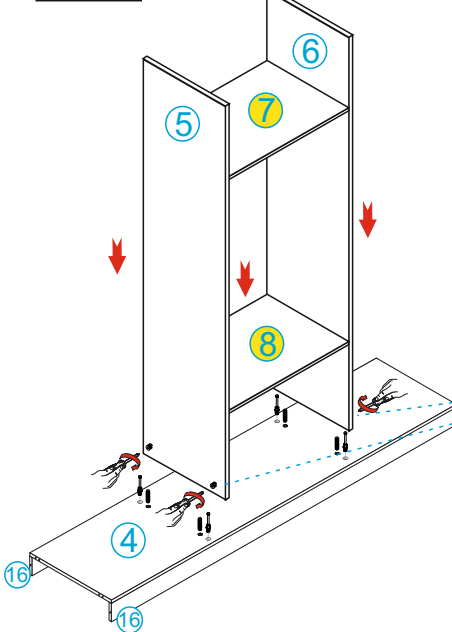

5. İşlem

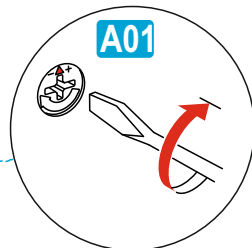
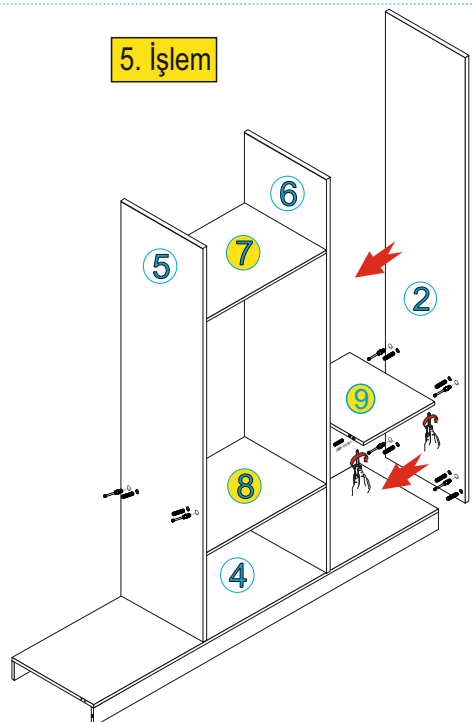

6. İşlem

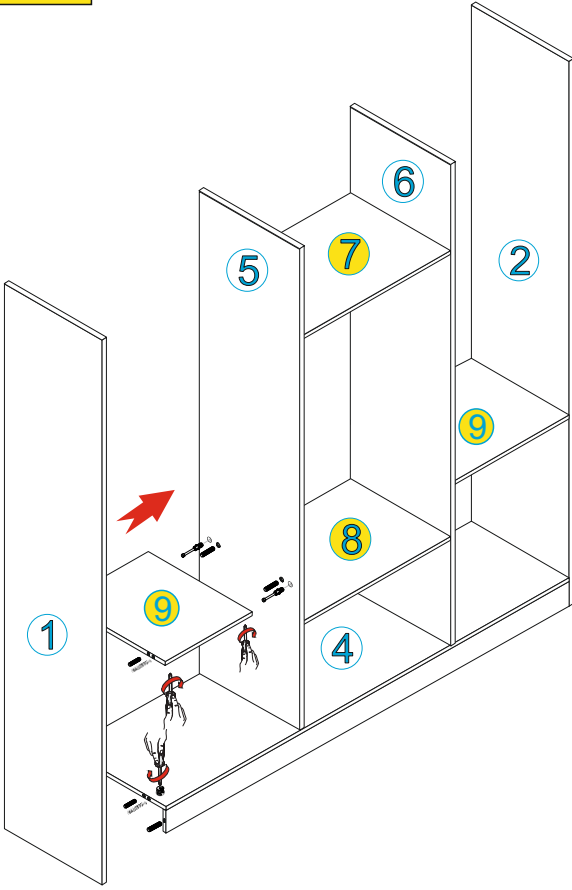

7. İşlem

* Arkalık çıtalarını (A07) kullanarak arkalıkları kanallara yerleştiriniz.

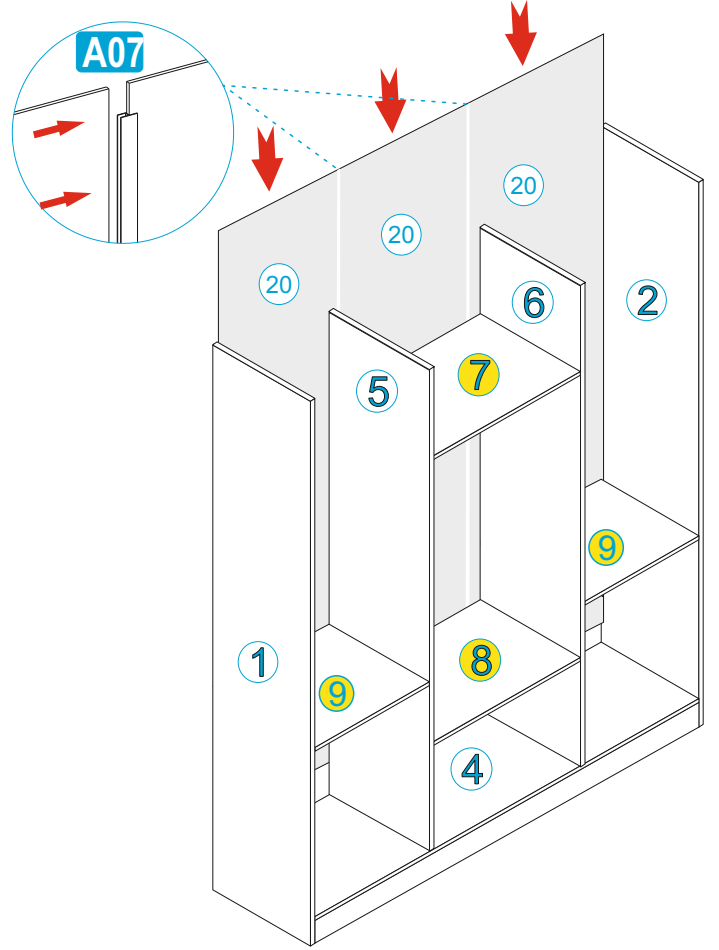

8. İşlem

* 4 numaralı parçayı sabitledikten sonra arkalık sabitleyicileri (A08) kullanarak arkalıkları 3,5 x 18 vida (A06) yardımıyla sabitleyiniz

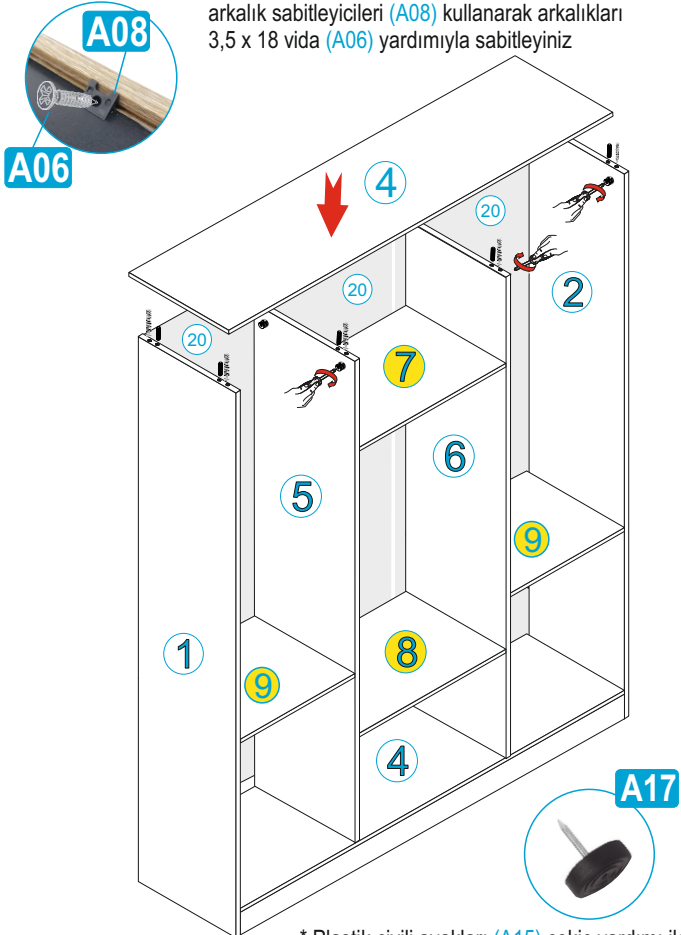

* Plastik çivili ayakları (A15) çekiç yardımı ile dolabın alt tarafına uygun şekilde çakınız.

9. İşlem

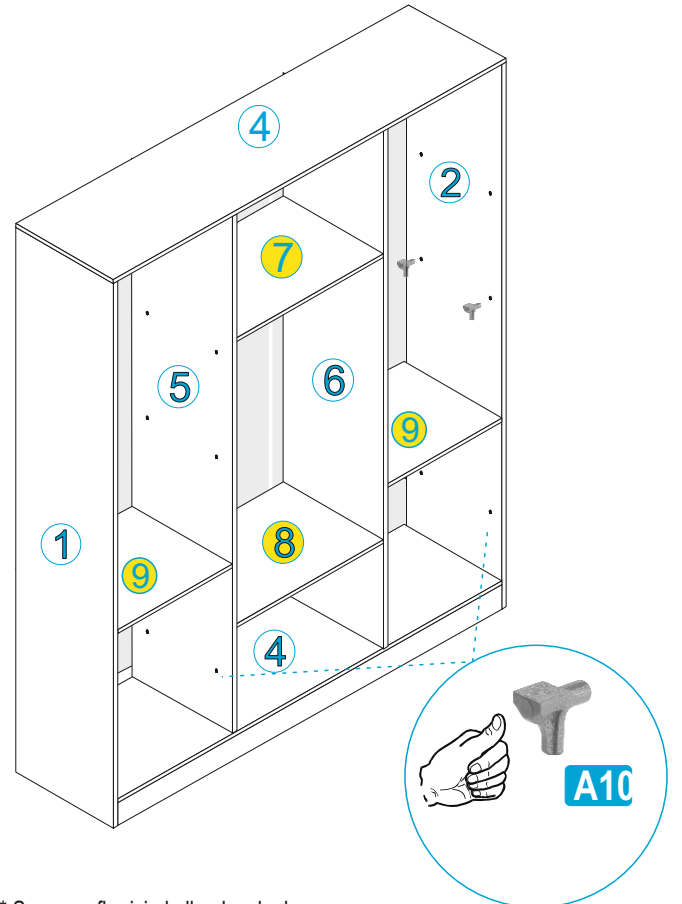

* Seyyar raflar için kullanılacak olan raf pimlerini (A10) yuvalarına yerleştiriniz.

10. İşlem

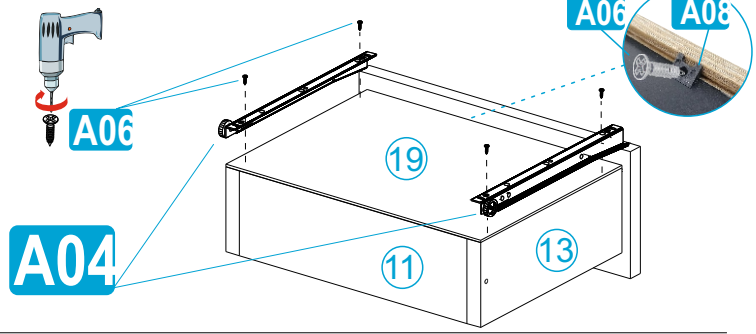
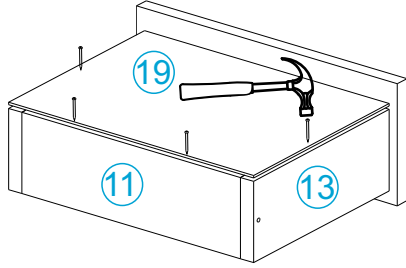
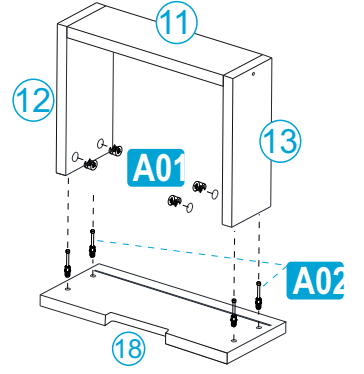
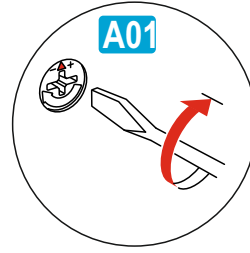
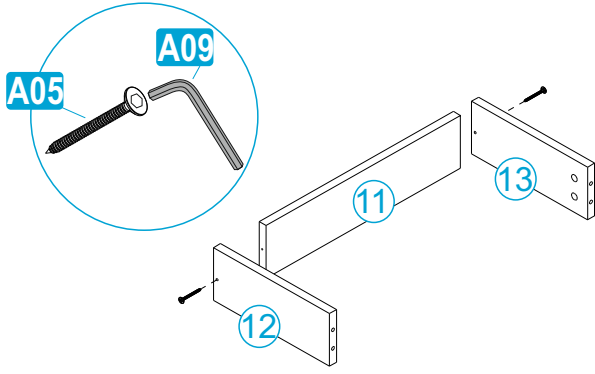

11. İşlem

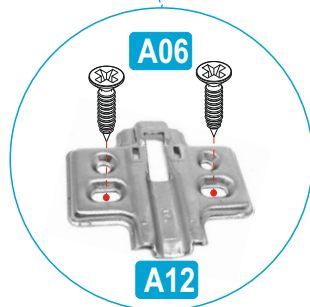
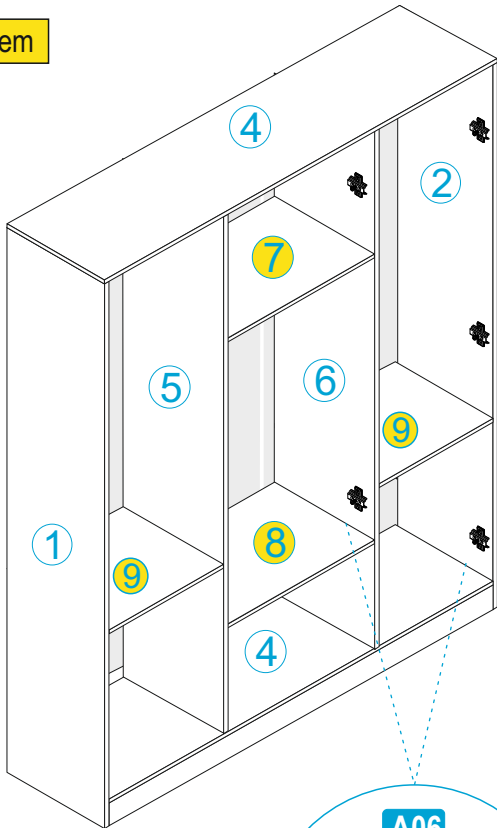

* Menteşe tabanlarını (A12) izi önceden belirlenen yerlere 3,5 x 18 vida (A06) yardımıyla sabitleyiniz.

12. İşlem

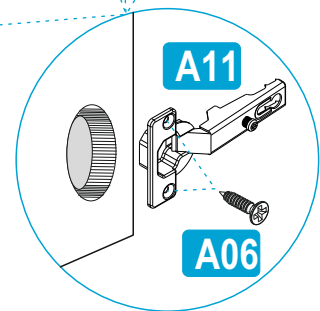
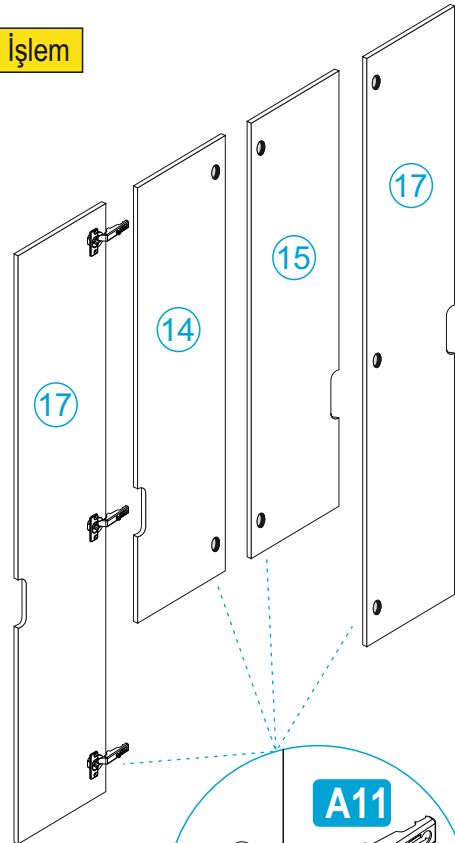

* Menteşeleri (A11) kapklardaki menteşe yuvalarına 3,5 x 18 vida (A06) yardımıyla sabitleyiniz ve menteşe tabanlarına takınız.

13. İşlem

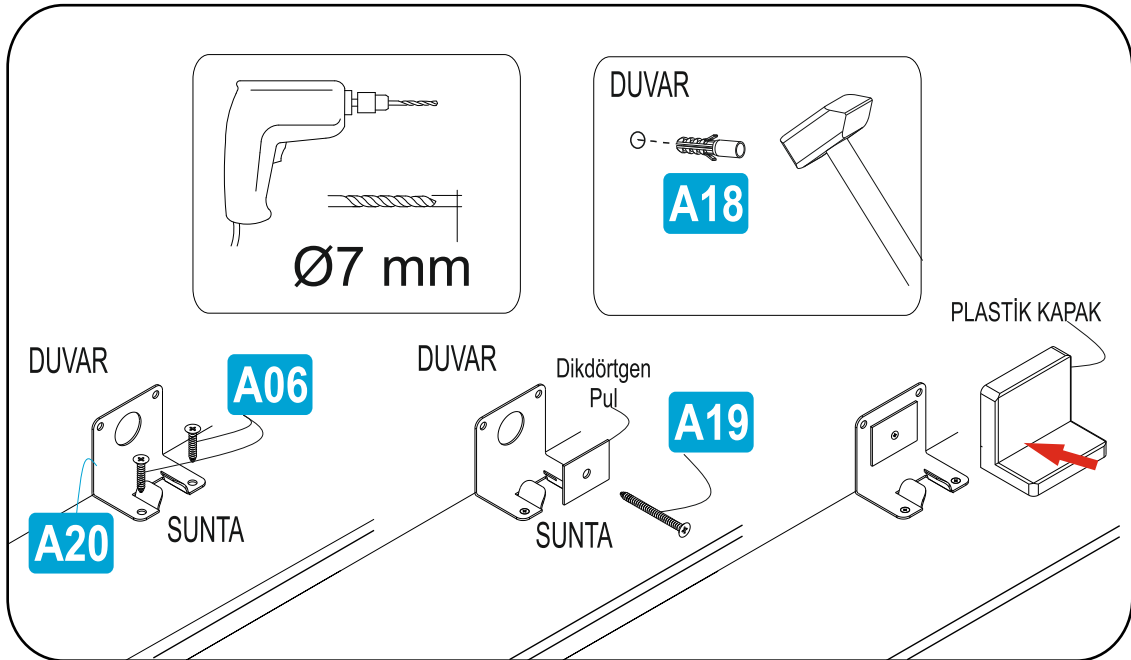
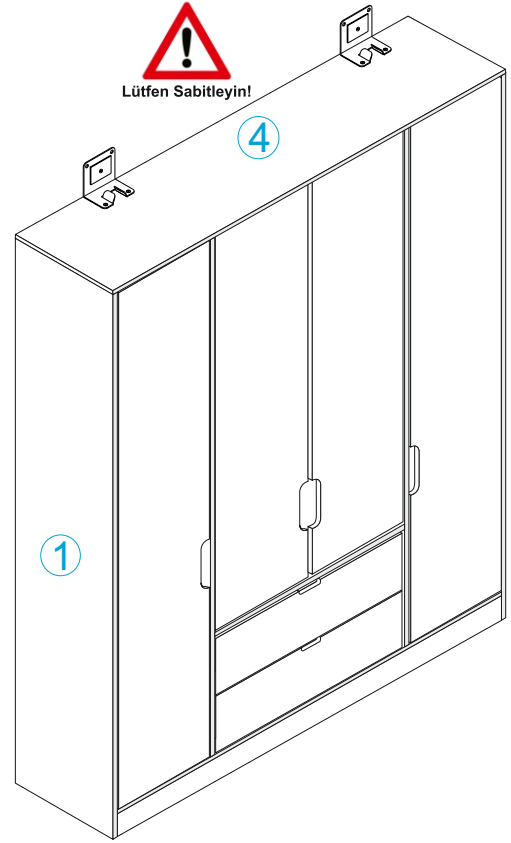
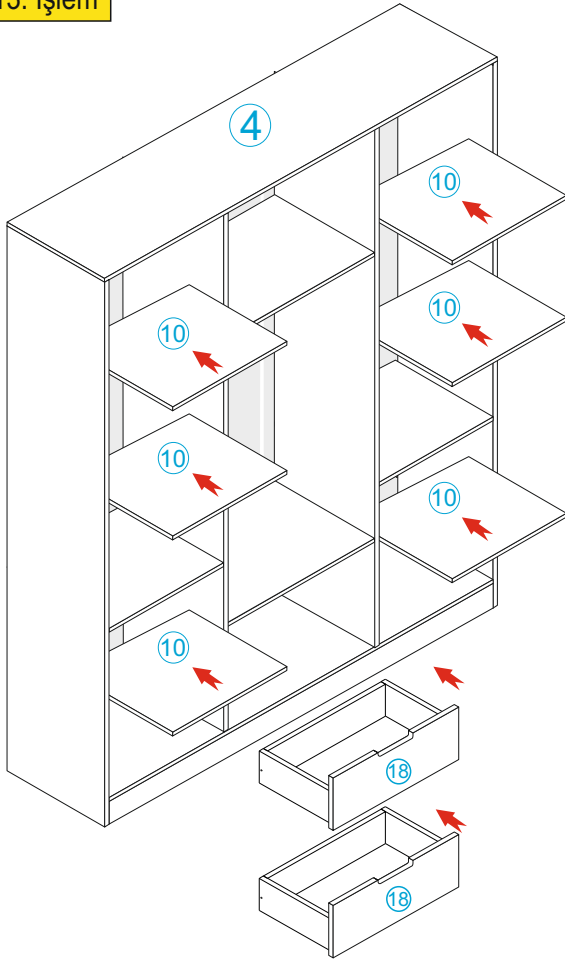

Lütfen Sabitleyin!

Sizin ve ailenizin güvenliği için, devrilmelerden kaynaklanan kazaları önlemenin en iyi yolu, mobilyaları sabitlemektir. Ürünün içinden çıkan; askı aparatı, dübel ve vidası ile ürünü üst tablasından duvara **SABİTLEYİNİZ**.

NOT
Duvar sabitleme aparatı paket içerisinde yok ise talep ediniz.

