

MONTAJ ŞEMASI

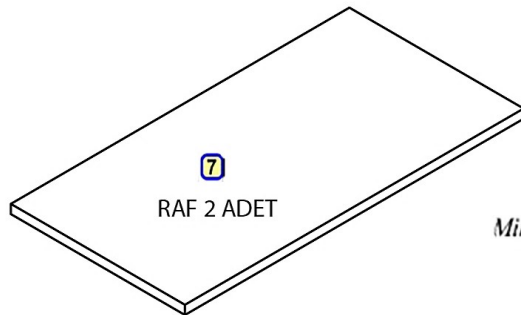

ADIM 1
1,2,3 Numaralı parçalara minifiks gövdeler ,ağız kısmı kenar deliğine bakacak şekilde yerleştirilir. Kavelar şekildeki gibi monte edilir.

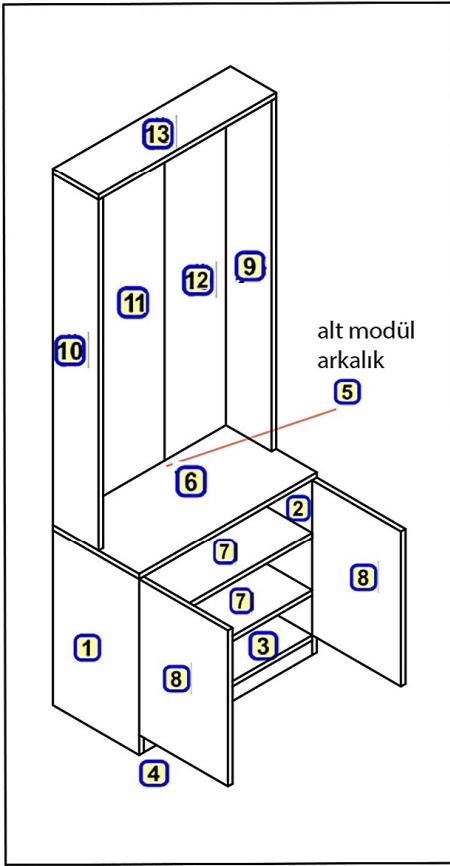
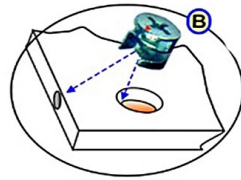
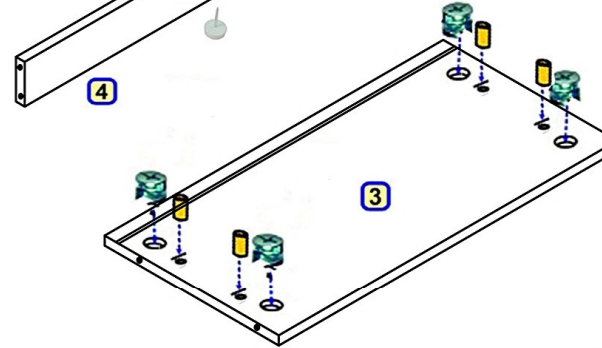
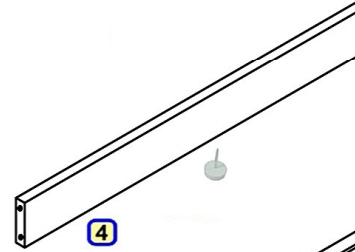
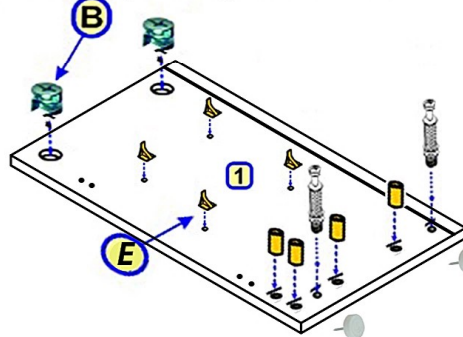

Minifiks gövdesinin ağız kısmı kenar deliğine bakacak şekilde takılmalıdır.

ADIM 2
1,2,6 Numaralı parçalarda çakılı olan dübellere minifiks miller gelecek şekilde çevriliyerek monte edilir.

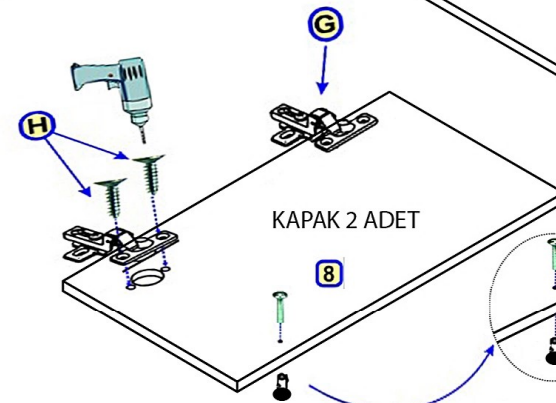
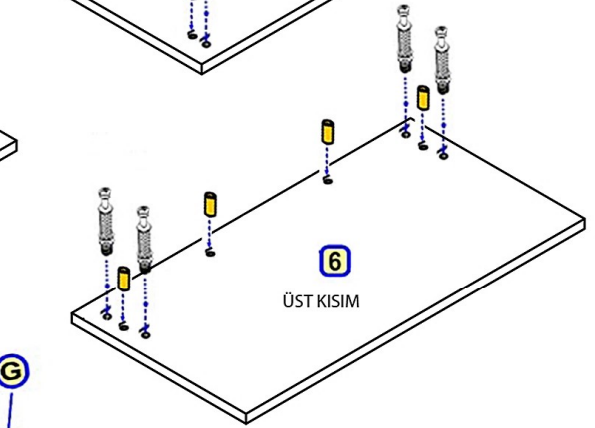
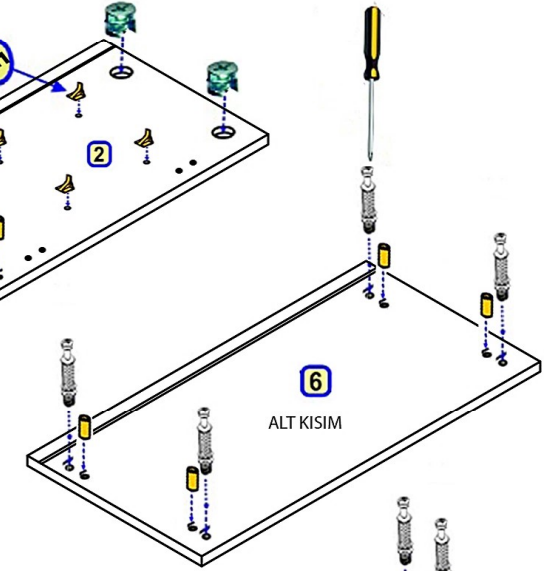
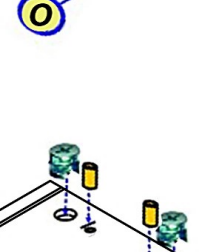
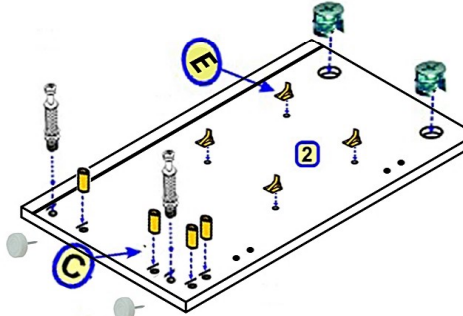

ADIM 3
Menteşeler,8 numaralı parçaya 3.5*18 lik vidalar ile vidalanır.Kulp, kulp vidası ile monte edilir.

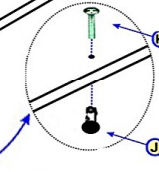

ADIM 4

9,10 VE 13 Numaralı parçalarda çakılı olan dübellere minifiks miller gelecek şekilde çevrilerek monte edilir.

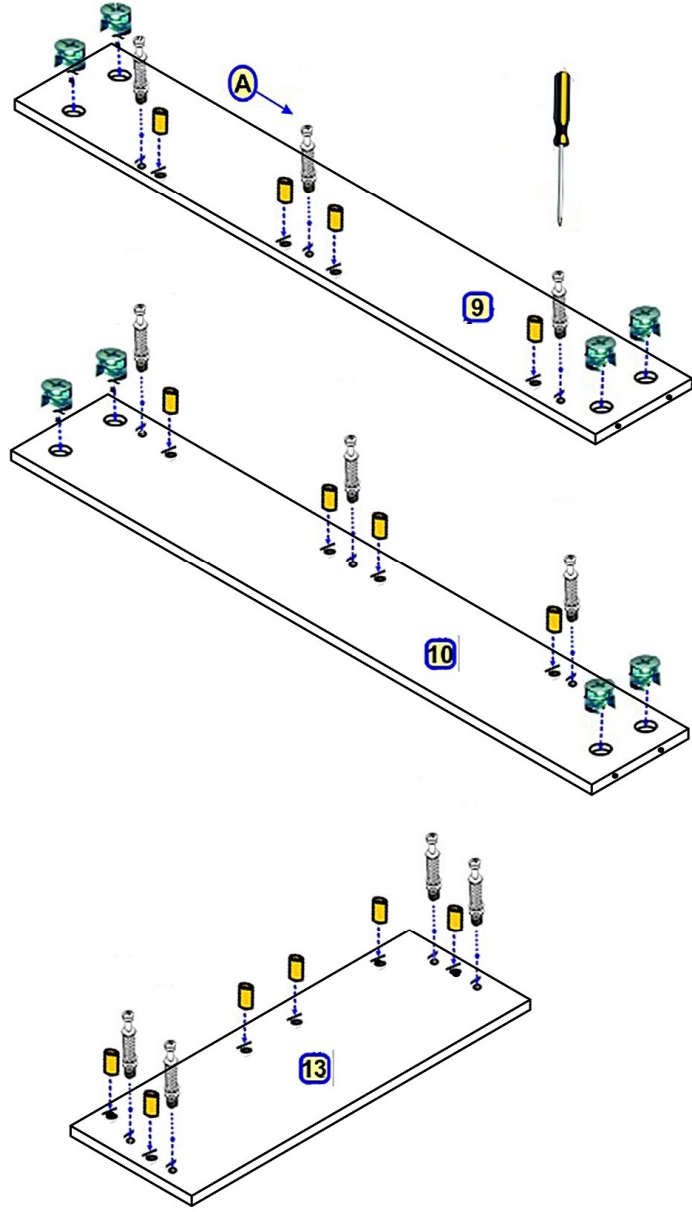

ADIM 5

11,12 Numaralı parçalara minifiks gövdeler ,ağız kısmı kenar deliğine bakacak şekilde yerleştirilir. Kavelalar şekildeki gibi monte edilir.

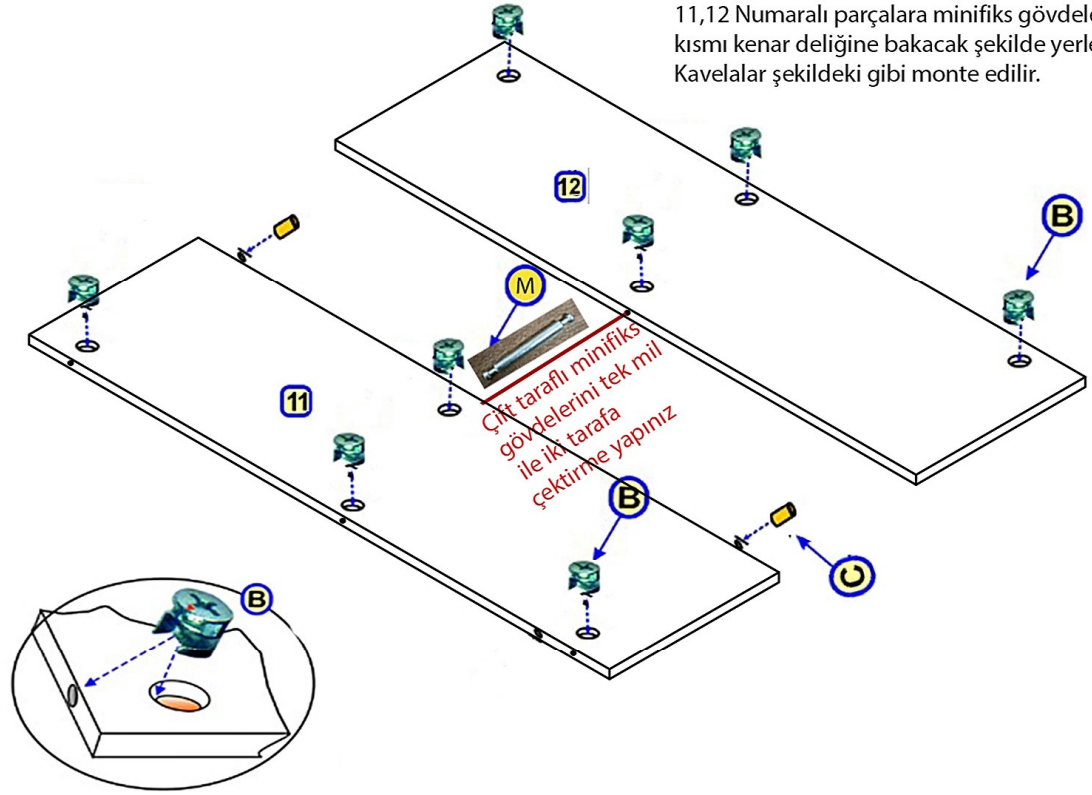

Minifiks gövdesinin ağız mutlaka kenar deliğine bakacak şekilde takılmalıdır.

ADIM 6

Askılıklar işaretlenmiş deliklere 3.5*18 lik vidalar ile monte edilir

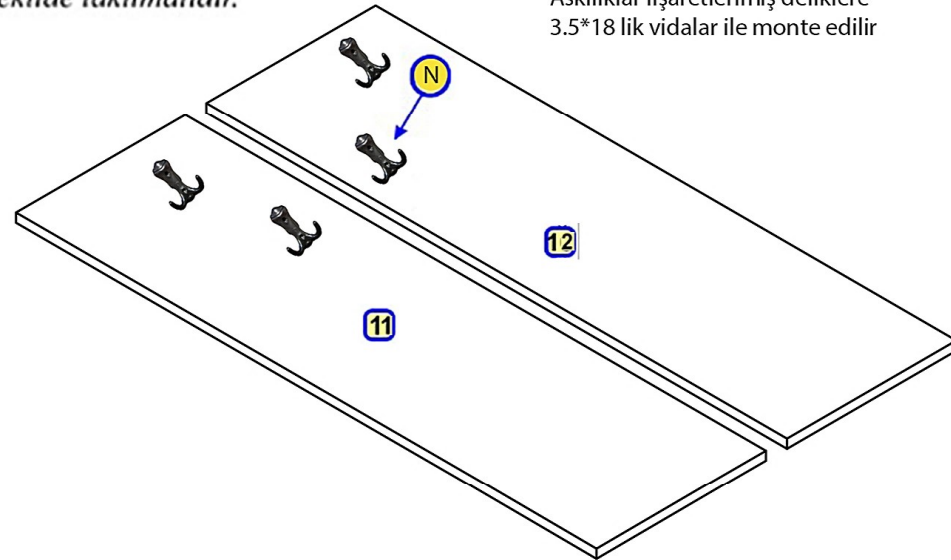

ADIM 7

1 ve 2 numaralı parçalar,3 ve 4 numaralı parçalara şekildeki gibi yerleştirilir.minifiks miller,gövdeye karşılık gelecek şekilde yerleştirildikten sonra , gövdeniz ağız kısmı torna vida ile çevrilir.

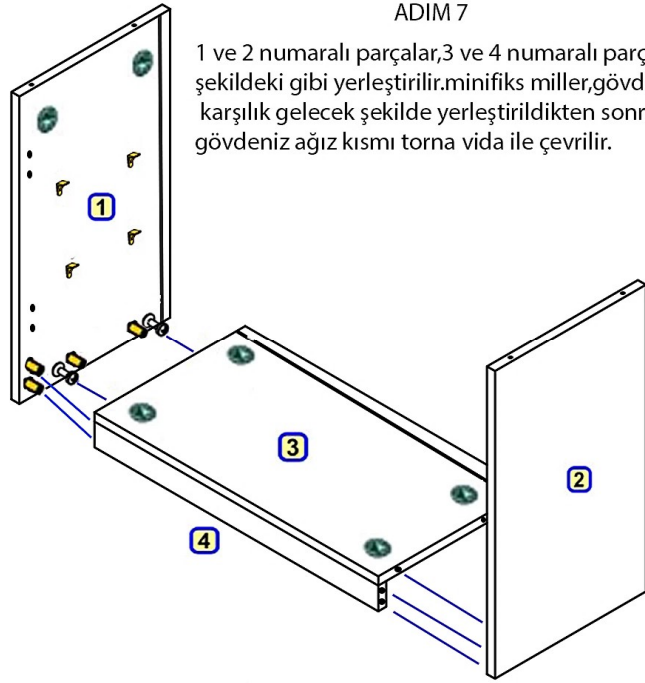

ADIM 8

5 numaralı arkalık 1 ve 2 numaralı parçaların kanallarından geçirilerek yerleştirilir.

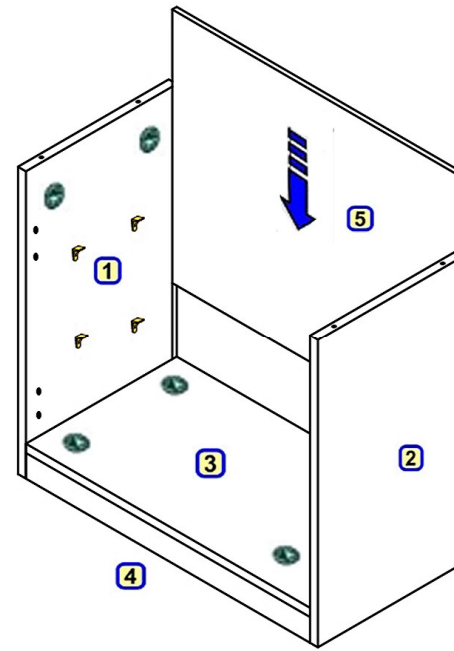

ADIM 9

6 numaralı parça 1 ve 2 numaralı parçalara yerleştirilir. Minifiks gövdenin ağız kısmı torna vida ile çevrilir.

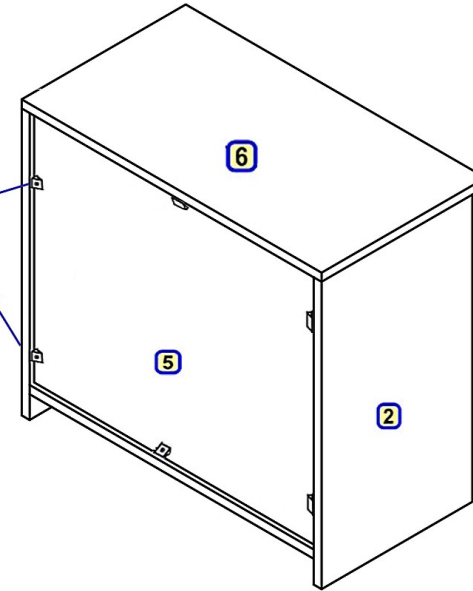
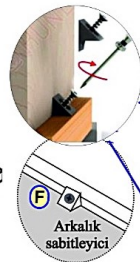
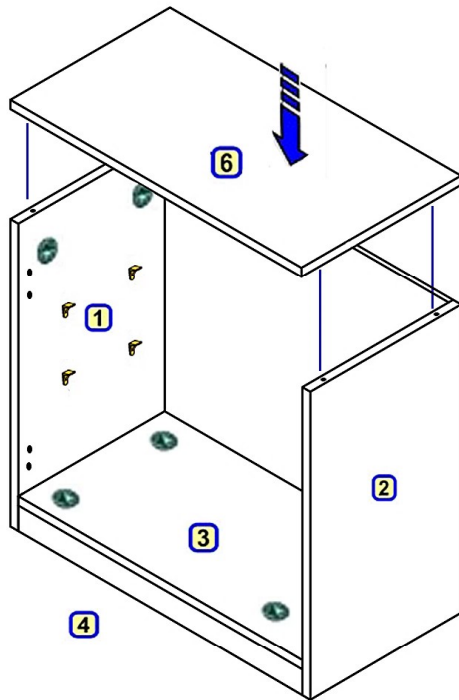

ADIM 10
Arkalık sabitleyiciler şekildeki gibi 3.5*18 lik vidalar ile kenarlara vidalanır.

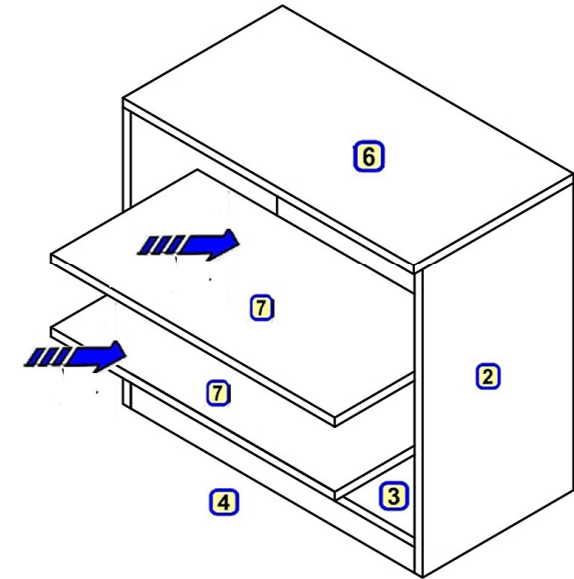

ADIM 11
7 numaralı parçalar raf pimlerinin üzerine gelecek şekilde yerleştirilir.

